





36 860 670



- 140mm projection
- fixed spout
- rectangular, air-enriched flow
- hole diameter spout 37 mm
- hole diameter single-lever mixer 57 mm
- rosette for spout 80 x 60mm
- rosette for mixer 80 x 80mm
- max. flow 5.7 l/min
- lead-free
- This product can help a building meet the requirements of Green Building Rating Systems, e.g. LEED®, BREEAM®, DGNB

| | | |
|---|------------------|---------------|
|  | Chrome | 36 860 670-00 |
|  | Brushed Platinum | 36 860 670-06 |
|  | Brushed Chrome | 36 860 670-93 |

Required miscellaneous

-  **Concealed wall-mounted single-lever mixer mixer on right -** 35 816 970 90
- NOTE:Not suitable for concealed installation.Connection by means of angle valves, mounted with screws to back wall.

Required miscellaneous

-  **Concealed wall-mounted single-lever mixer -** 35 860 970 90
- max. recess depth 95 mm
 - min. recess depth 80 mm

36 860 670

mm [inches]

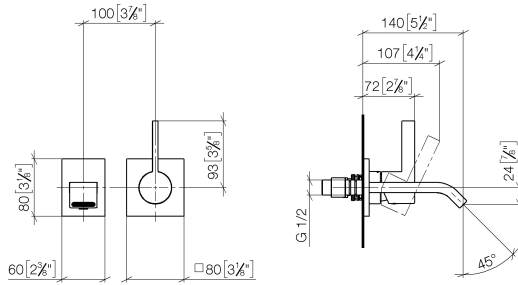

Flow rate chart



Certificates

LGA_29906.

DVGW_DW-
6512DN0435.

WRAS_2107018.

36 860 670

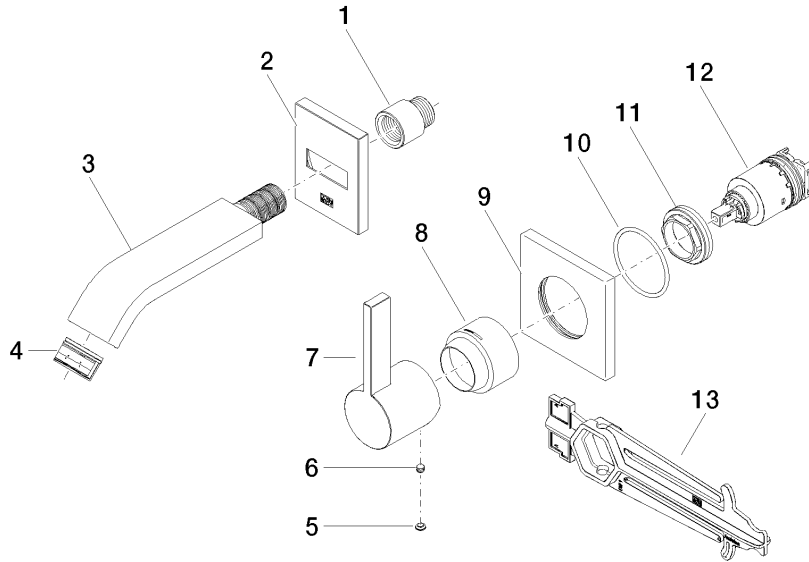

Spare parts list

| No. | Item Number | Name | Quantity used | Delivery time |
|-----|--------------------|-----------|---------------|---------------|
| 1 | 09 24 03 072 10 90 | nipple | 1 | 2 |
| 2 | 90 27 67 005 00-00 | rosette | 1 | 10 |
| 3 | 04 28 22 242 00-00 | spout | 1 | 10 |
| 4 | 90 29 03 109 00 90 | aerator | 1 | 2 |
| 5 | 90 31 20 087 00-00 | plug | 1 | 10 |
| 6 | 90 31 11 112 00 90 | pin | 1 | 2 |
| 7 | 09 20 67 004-00 | handle | 1 | 10 |
| 8 | 09 11 02 530-00 | cover | 1 | 10 |
| 9 | 09 27 78 039-00 | rosette | 1 | 10 |
| 10 | 90 14 10 049 00 90 | seal | 1 | 2 |
| 11 | 09 24 04 105 90 | nut | 1 | 2 |
| 12 | 90 15 05 064 01 90 | cartridge | 1 | 2 |
| 13 | 90 30 09 064 00 90 | key | 1 | 2 |